

TB8220U Commercial VisionPRO™ Programmable Thermostat

INSTALLATION INSTRUCTIONS

APPLICATION

The TB8220U Programmable Thermostat provides electronic control of 24 Vac heating and cooling systems. See Table 1 for a description.

Table 1. TB8220U Thermostat Description.

Feature	Description
Powering Methods	<ul style="list-style-type: none"> Battery only Direct connection to a 24 Vac transformer only Direct connection to a 24 Vac transformer with battery backup
System Types	<ul style="list-style-type: none"> Conventional (up to 2 Heat, 2 Cool stages) Heat Pump (up to 3 Heat, 2 Cool stages)
Changeover	Manual or automatic changeover (selectable)
System Setting	Heat-Off-Cool-Auto
Fan Setting	Auto-On



MERCURY NOTICE

If this control is replacing a control that contains mercury in a sealed tube, do not place your old control in the trash. Dispose of properly.

Contact your local waste management authority for instructions regarding recycling and the proper disposal of an old control.

INSTALLATION

When Installing this Product...

1. Read these instructions carefully. Failure to follow them could damage the product or cause a hazardous condition.
2. Check ratings given in instructions and on the product to ensure the product is suitable for your application.
3. Installer must be a trained, experienced service technician.
4. After installation is complete, check out product operation as provided in these instructions.

Select Thermostat Location

Select a location for the thermostat about 5 ft (1.5m) above the floor in an area with good air circulation at average temperature. See Fig. 1.

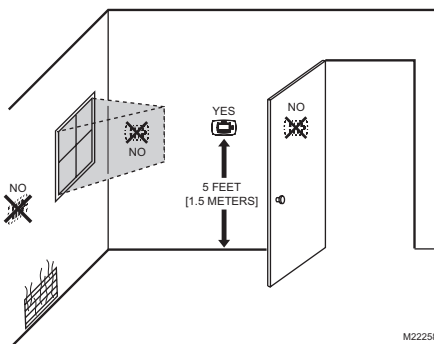

Fig. 1. Select thermostat location.

Do not install the thermostat where it can be affected by:

- Drafts or dead spots behind doors and in corners.
- Hot or cold air from ducts.
- Radiant heat from sun or appliances.
- Concealed pipes and chimneys.
- Unheated (uncooled) areas such as an outside wall behind the thermostat.



CAUTION

Electrical Shock or Equipment Damage Hazard.

Can shock individuals or short equipment circuitry.

Disconnect power supply before installation.



Separate Wallplate from Thermostat

1. Separate the wallplate from the thermostat. See Fig. 2.

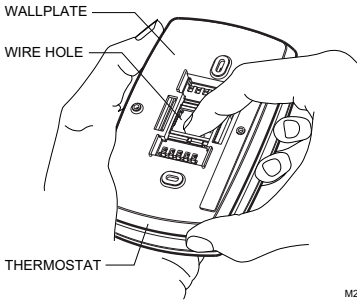

M22267

Fig. 2. Separate wallplate from thermostat.

NOTES:

- Sensor wires must have a cable separate from the thermostat control cable.
- Refer to Table 2 for terminal designation descriptions.
- See Fig. 7 through 17 for wiring diagrams for specific equipment applications.

1. Select set of terminal identifications that correspond to your system type (conventional or heat pump). (See Fig. 4).

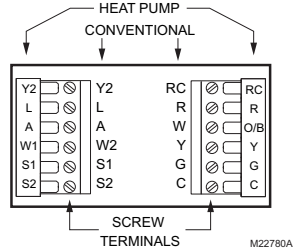

M22780A

Fig. 4. Terminal identifications for system type.

2. Loosen screw terminals used for the application.
3. Insert the wires into the terminal block and tighten each screw terminal. See Fig. 5.

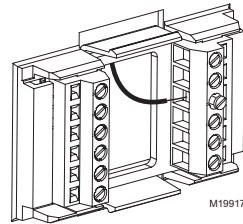
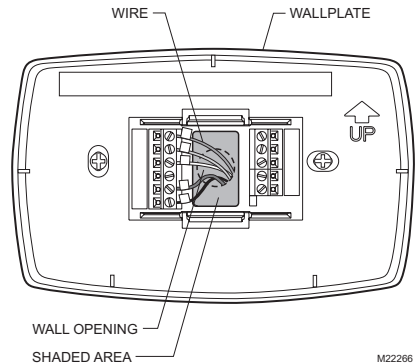

Fig. 5. Insert wires into terminal block.

4. Push excess wire back into the wall opening and restrict wires to the shaded area. See Fig. 6.
5. Plug the wall opening with nonflammable insulation to prevent drafts from affecting the thermostat.



M22266

Fig. 6. Restrict wires to shaded area of wire hole.

Install Wallplate (See Fig. 3)

Mount the thermostat horizontally on the wall:

1. Pull the wires through the wire hole on the wallplate.
2. Position the wallplate on the wall with the arrow pointing up. Level the wallplate for appearance only.
3. Use a pencil to mark the mounting holes.
4. Remove the wallplate from the wall and drill two 3/16 in. holes in the wall (if drywall) as marked. For firmer material such as plaster, drill two 7/32 in. holes. Tap the wall anchors (provided) into the drilled holes until flush with the wall.
5. Pull the wires through the wire hole on the wallplate and position the wallplate over the wall anchors.
6. Insert the mounting screws into the wall anchors and tighten.

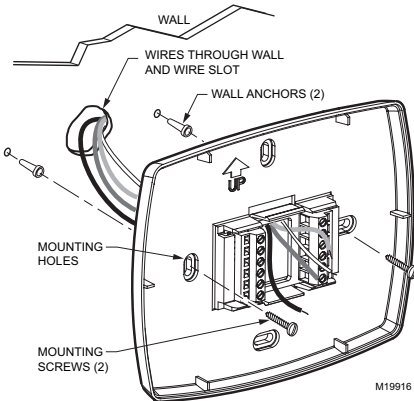

M19916

Fig. 3. Install wallplate.

WIRING

IMPORTANT

- All wiring must agree with applicable codes, ordinances and regulations.
- Use 18 gauge thermostat wire. Shielded cable is not required.

Table 2. Terminal Designation Descriptions.

Terminal Designation	Description
Rc (see Note 1)	Power for cooling—connect to secondary side of cooling system transformer.
R (see Note 1)	Power for heating—connect to secondary side of heating system transformer.
Y	Compressor output.
C (see Note 2)	Common wire from secondary side of cooling system transformer.
W	Heat relay.
G	Fan relay.
W2	Second stage heat relay.
Y2	Second stage cooling.
O/B (see Note 3)	Changeover valve for heat pumps.
A (see Note 4)	Economizer/Time-Of-Day (TOD) output—powered via R terminal.
S1 (See Note 5)	Optional outdoor or indoor remote sensor.
S2 (See Note 5)	Optional outdoor or indoor remote sensor.
L	Powers red LED behind plastic in upper right corner of the thermostat.

NOTES:

- When used in a single-transformer system, leave metal jumper wire in place between Rc and R. If used on a two-transformer system, remove metal jumper wire between Rc and R.
- Common wire is optional when thermostat is used with batteries. When using separate transformers for heating and cooling, the common must come from the cooling transformer.
- If thermostat is configured for a heat pump in the Installer Setup, configure changeover valve for cool (O-factory setting) or heat (B).
- Reference economizer literature for wiring details. When set for economizer operation, the A terminal provides the occupancy signal. (Power indicates occupied.)
- Sensor wires must have a cable separate from the thermostat control cable.

Table 3. Wiring Diagrams.

System Type	Wallplate Terminal Identifications	Wiring Diagram Figure
Standard Heat/Cool	Conventional	7, 8
Heat Only	Conventional	9
Heat Only with Fan	Conventional	10
Cool only	Conventional	11
Standard Multistage up to 2 Heat/2 Cool	Conventional	12, 13
Heat Pump (No Auxiliary Heat)	Heat Pump	14, 15
Heat Pump (with Auxiliary Heat)	Heat Pump	16, 17
Multiple T7770A Sensors	—	18, 19, 20
Multiple C7189U Sensors	—	21

Terminal “A” Wiring Details for Economizers

- Wire the A terminal to the W7212 “N” terminal, or the W7459 “TR” terminal.
- When using dual transformers at the thermostat, the heating transformer must power the economizer.
- The A signal is powered from the R terminal and energizes the economizer to signal occupied status and drive the damper to the set minimum position.

Conventional System Wiring

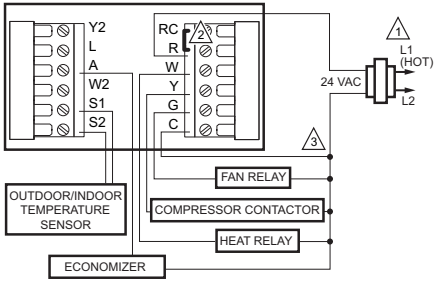

- 1 POWER SUPPLY. PROVIDE DISCONNECT MEANS AND OVERLOAD PROTECTION AS REQUIRED.
- 2 FACTORY INSTALLED JUMPER.
- 3 WHEN USING BATTERIES, THE 24V COMMON CONNECTION IS OPTIONAL.

Fig. 7. Typical wiring of single transformer 1H/1C system.

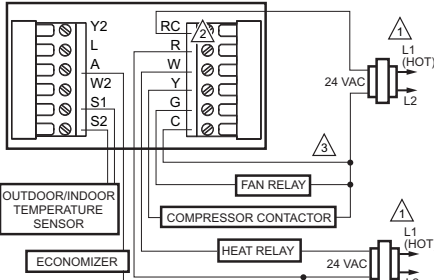

- 1 POWER SUPPLY. PROVIDE DISCONNECT MEANS AND OVERLOAD PROTECTION AS REQUIRED.
- 2 REMOVE FACTORY INSTALLED JUMPER.
- 3 WHEN USING BATTERIES, THE 24V COMMON CONNECTION IS OPTIONAL. WHEN USED, THE COMMON MUST CONNECT TO THE COOLING TRANSFORMER SECONDARY.

Fig. 8. Typical hookup of dual transformer 1H/1C system.

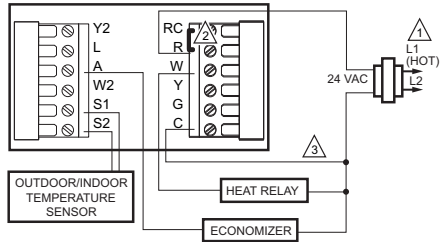

- 1 POWER SUPPLY. PROVIDE DISCONNECT MEANS AND OVERLOAD PROTECTION AS REQUIRED.
- 2 FACTORY INSTALLED JUMPER.
- 3 WHEN USING BATTERIES, THE 24V COMMON CONNECTION IS OPTIONAL.

Fig. 9. Typical hookup of heat-only system.

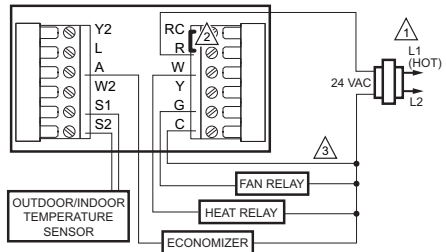

- 1 POWER SUPPLY. PROVIDE DISCONNECT MEANS AND OVERLOAD PROTECTION AS REQUIRED.
- 2 FACTORY INSTALLED JUMPER.
- 3 WHEN USING BATTERIES, THE 24V COMMON CONNECTION IS OPTIONAL.

Fig. 10. Typical hookup of heat-only system with fan.

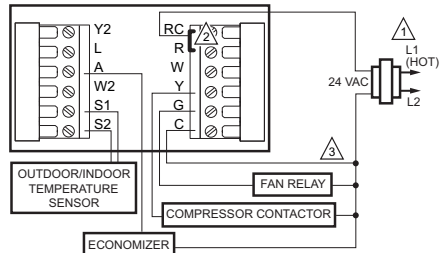

- 1 POWER SUPPLY. PROVIDE DISCONNECT MEANS AND OVERLOAD PROTECTION AS REQUIRED.
- 2 FACTORY INSTALLED JUMPER.
- 3 WHEN USING BATTERIES, THE 24V COMMON CONNECTION IS OPTIONAL.

Fig. 11. Typical hookup of cool-only system.

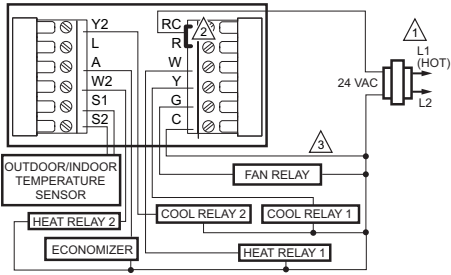

- 1 POWER SUPPLY. PROVIDE DISCONNECT MEANS AND OVERLOAD PROTECTION AS REQUIRED.
- 2 FACTORY INSTALLED JUMPER.
- 3 WHEN USING BATTERIES, THE 24V COMMON CONNECTION IS OPTIONAL.

M22786A

Fig. 12. Typical hookup of single transformer multistage system (up to 2H/2C).

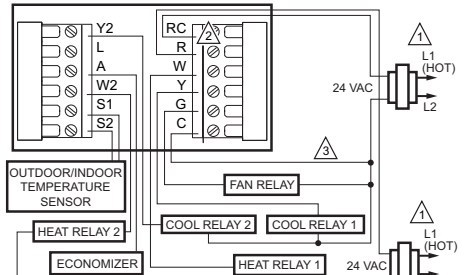

- 1 POWER SUPPLY. PROVIDE DISCONNECT MEANS AND OVERLOAD PROTECTION AS REQUIRED.
- 2 REMOVE FACTORY INSTALLED JUMPER.
- 3 WHEN USING BATTERIES, THE 24V COMMON CONNECTION IS OPTIONAL. WHEN USED, THE COMMON MUST CONNECT TO THE COOLING TRANSFORMER SECONDARY.

M22787A

Fig. 13. Typical hookup of dual transformer multistage system (up to 2H/2C).

Heat Pump System Wiring

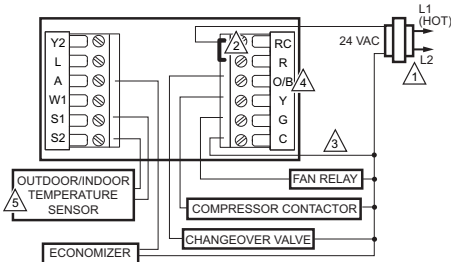

- 1 POWER SUPPLY. PROVIDE DISCONNECT MEANS AND OVERLOAD PROTECTION AS REQUIRED.
- 2 FACTORY INSTALLED JUMPER.
- 3 WHEN USING BATTERIES, THE 24V COMMON CONNECTION IS OPTIONAL.
- 4 "O/B" TERMINAL SET TO CONTROL AS EITHER "O" OR "B" IN THE INSTALLER SETUP.
- 5 OPTIONAL OUTDOOR OR INDOOR REMOTE SENSOR. AVAILABLE ON SELECT MODELS. WIRES MUST HAVE A CABLE SEPARATE FROM THE THERMOSTAT CABLE.

M22788A

Fig. 14. Typical hookup of single-stage heat pump with no auxiliary heat (1H/1C).

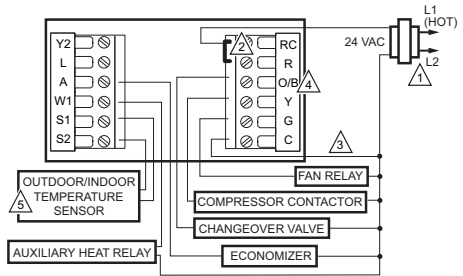

- 1 POWER SUPPLY. PROVIDE DISCONNECT MEANS AND OVERLOAD PROTECTION AS REQUIRED.
- 2 FACTORY INSTALLED JUMPER.
- 3 WHEN USING BATTERIES, THE 24V COMMON CONNECTION IS OPTIONAL.
- 4 "O/B" TERMINAL SET TO CONTROL AS EITHER "O" OR "B" IN THE INSTALLER SETUP.
- 5 OPTIONAL OUTDOOR OR INDOOR REMOTE SENSOR. AVAILABLE ON SELECT MODELS. WIRES MUST HAVE A CABLE SEPARATE FROM THE THERMOSTAT CABLE.

M22790A

Fig. 16. Typical hookup of single-stage heat pump with auxiliary heat (2H/1C).

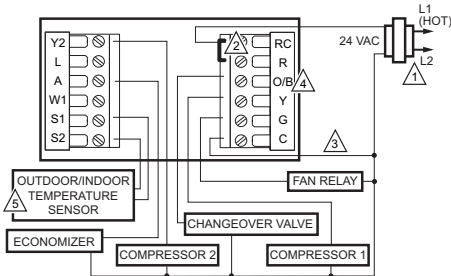

- 1 POWER SUPPLY. PROVIDE DISCONNECT MEANS AND OVERLOAD PROTECTION AS REQUIRED.
- 2 FACTORY INSTALLED JUMPER.
- 3 WHEN USING BATTERIES, THE 24V COMMON CONNECTION IS OPTIONAL.
- 4 "O/B" TERMINAL SET TO CONTROL AS EITHER "O" OR "B" IN THE INSTALLER SETUP.
- 5 OPTIONAL OUTDOOR OR INDOOR REMOTE SENSOR. AVAILABLE ON SELECT MODELS. WIRES MUST HAVE A CABLE SEPARATE FROM THE THERMOSTAT CABLE.

M22789A

Fig. 15. Typical hookup of multistage heat pump with no auxiliary heat (2H/2C).

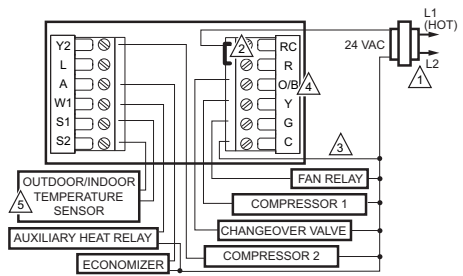

- 1 POWER SUPPLY. PROVIDE DISCONNECT MEANS AND OVERLOAD PROTECTION AS REQUIRED.
- 2 FACTORY INSTALLED JUMPER.
- 3 WHEN USING BATTERIES, THE 24V COMMON CONNECTION IS OPTIONAL.
- 4 "O/B" TERMINAL SET TO CONTROL AS EITHER "O" OR "B" IN THE INSTALLER SETUP.
- 5 OPTIONAL OUTDOOR OR INDOOR REMOTE SENSOR. AVAILABLE ON SELECT MODELS. WIRES MUST HAVE A CABLE SEPARATE FROM THE THERMOSTAT CABLE.

M22791A

Fig. 17. Typical hookup of multistage heat pump with auxiliary heat (3H/2C).

Sensor Wiring for Temperature Averaging

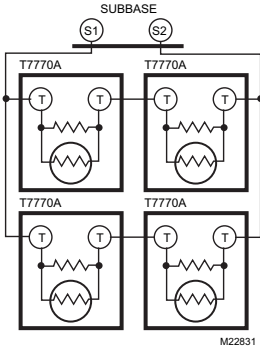

Fig. 18. Wiring four T7770A1006 (20K ohm) Sensors.

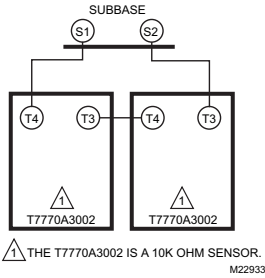

Fig. 19. Wiring two T7770A3002 (10K ohm) Sensors to provide a temperature averaging network.

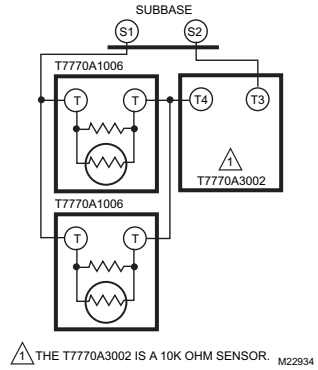

Fig. 20. Wiring two T7770A1006 (20K ohm) Sensors and one T7770A3002 (10K ohm) sensor to provide a temperature averaging network

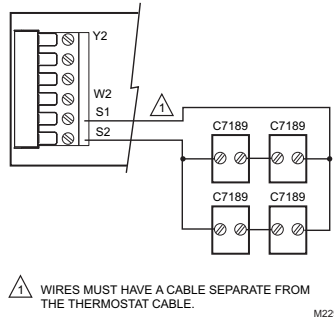

Fig. 21. Wiring four C7189U (10K ohm) Sensors to provide a temperature averaging network.

POWER THE THERMOSTAT

You can choose from three methods to power the thermostat:

- Batteries only (AAA alkaline).
- 24 Vac direct connection only.
- 24 Vac direct connection with battery backup (AAA alkaline).

Wiring 24 Vac Common

- Single-Transformer System—Connect the common side of the transformer to the C screw terminal of the thermostat wallplate. Leave the metal jumper wire in place between Rc and R.
- Two-Transformer System—Connect the common side of the cooling transformer to the C screw terminal of the thermostat wallplate. Remove the metal jumper wire between Rc and R.

Installing Batteries

1. Install three AAA alkaline batteries on the back of the thermostat as marked. See Fig. 22.

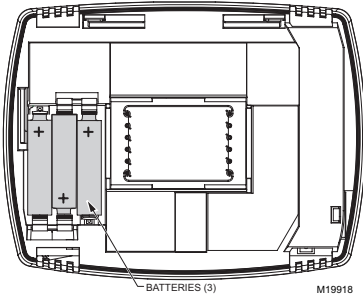

Fig. 22. Installing batteries.

2. Locate and remove the tab labeled Remove. See Fig. 23.

IMPORTANT

This tab must be removed in order to set the real-time clock.

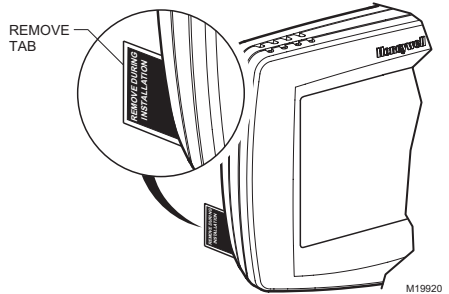

Fig. 23. Remove tab labeled REMOVE from thermostat back.

Setting Calendar and Time

Setting Calendar

This thermostat is designed to, under normal use, automatically keep current time and day in memory for up to ten years once the calendar is set. There are two ways to set the calendar for this thermostat:

SETTING CALENDAR WHEN THERMOSTAT IS FIRST POWERED
When the thermostat is first powered, the display is ready to set the calendar and time. The thermostat proceeds through a sequence of setup screens. See Fig. 24.

SETTING CALENDAR AFTER THERMOSTAT IS ALREADY FUNCTIONING

See steps 1 through 4, in the Advanced Settings section, to set year, month and day.

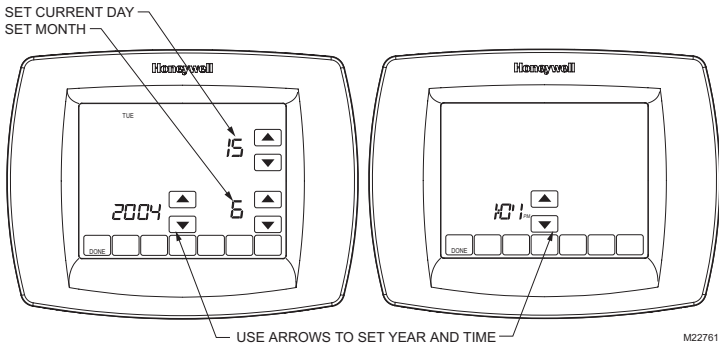

Fig. 24. Setting calendar and time after initial powerup.

Mount Thermostat to Wallplate

1. Align the terminal screw blocks with the pins on the back of the thermostat.
2. Push the thermostat straight onto the wallplate until it snaps into place. See Fig. 25.

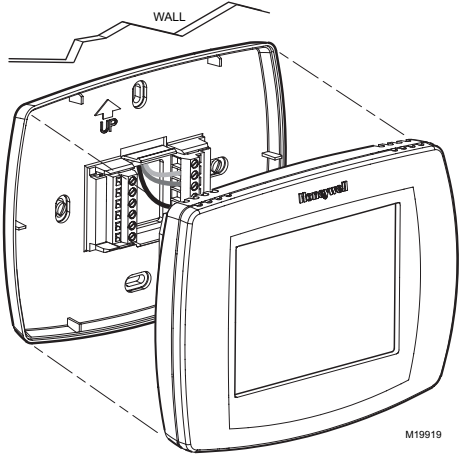

Fig. 25. Mount thermostat to wallplate.

Advanced Settings

The thermostat has advanced settings to match the HVAC system. These settings can be adjusted to match specific needs. Access to these settings is obtained as follows:

1. From the main screen, press SYSTEM. Five blank touch keys show on the bottom of the screen between DONE and CANCEL.
2. Press and hold the two blank keys on either side of the center blank key for approximately five seconds. (See Fig. 26.)
3. The Setup Number displays to the lower-left area of the screen. It is a four-digit code beginning with zero. The current setting is displayed to the right.

NOTE: To cycle through the Setup Numbers, press the up or down arrow.

INSTALLER SETUP NUMBERS, SETTINGS, AND TESTS (TABLE 4)

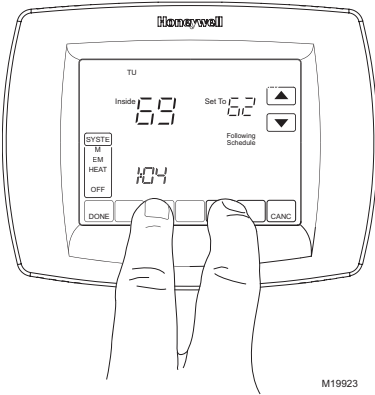

Fig. 26. Entering Installer Setup.

Installer System Tests

Use the Installer System Test to test the heating, cooling and fan. Refer to the latter portion of Table 4.

CAUTION

Equipment Damage Hazard.
Minimum compressor off time is bypassed during Installer System Test
 Avoid cycling compressor quickly.

IMPORTANT

Use *Installer System Test* to test heating, cooling and fan. The setting chosen for System Type (Installer Setup Number 0170) can prevent some System Test Numbers from appearing.

Table 4. Installer Setup Menu.

Installer Setup Number	Installer Setup Name	Default Setting	All Settings	Notes
0120	Date (Year Upper)	20	20—20xx 21—21xx	Available year range: 2001 - 2178
0130	Date (Year Lower)	04	00-99	Available year range: 2001 - 2178
0140	Date (Month)	6	1-12	
0150	Date (Day)	15	1-31 (Month Dependent)	

Table 4. Installer Setup Menu. (Continued)

Installer Setup Number	Installer Setup Name	Default Setting	All Settings	Notes
0160	Schedule Options	4	0—Non-Programmable 4—Programmable	
0170	System Selection	8	1—1H/1C Conv 2—1H/1C HP 3—1H w/o fan 4—1H with fan 6—1C 7—2H/1C HP 8—2H/2C Conv 9—2H/1C Conv 10—1H/2C Conv 11—2H/2C HP 12—3H/2C HP	
0175	TOD/Economizer output (terminal A)	0	0—Unused 1—TOD 2—Economizer	Economizer energizes A during a call for cool. TOD energizes A during Occupied period, and de-energizes A during Unoccupied.
0180	Heat Fan Operation	0	0—Fossil 1—Electric	Only shown for conventional system with heat stages and fan capability selected. If heat pump is selected, fan defaults to electric.
0185	Pre-occupancy Purge Duration	0	0—no duration 1—one hour 2—two hours 3—three hours	Shown only if system has fan and schedule programmable. Pre-occupancy purge enabled by nonzero duration (and sends economizer to minimum position).
0190	Reversing Valve O/B	0	0—O (O/B On Cool) 1—B (O/B On Heat)	Only shown with heat pump system selected.
0220	Cycles Per Hour (CPH) for first stage compressor	3	1-6	Only shown for system with cool stages. Selection in this stage changes default CPH of second stage cool.
0230	CPH for second stage compressor	3	1-6	Only shown if two stages of cool selected.
0240	CPH for first stage conventional heat	5	1-12	Only shown if system is conventional with heat stages. Selection in this stage changes default CPH of second stage heat.
0250	CPH for second stage conventional heat	9	1-12	Only shown with at least two stages conventional heat or 2H/1C heat pump selected.
0260	CPH for third Stage Heat	9	1-12	Only shown if 3H/2C heat pump is selected.
0270	CPH for Auxiliary Heat	9	1-12	Only shown if multi-stage heat pump is selected (heat pump with more heat than cool stages).
0280	Continuous Backlight	0	0—No 1—Yes	Always shown. If AC power not present the option is overridden and normal backlight operation occurs.
0300	Changeover	1	0—Manual 1—Auto	Only shown if system has both heat and cool stages.
0310	Deadband	3°F (2°C)	2 (1.5)—2°F (1.5°C) 3 (2.0)—3°F (2.0°C) 4 (2.5)—4°F (2.5°C) 5 (3.0)—5°F (3.0°C) 6 (3.5)—6°F (3.5°C) 7 (4.0)—7°F (4.0°C) 8 (4.5)—8°F (4.5°C) 9 (5.0)—9°F (5.0°C)	Only shown if Automatic Changeover Selected
0320	Temperature Indication Scale	0	0—°F 1—°C	
0330	Daylight Saving	2	0—Disabled 1—Enabled (US 1987) 2—Enable (US 2007) 3—Enabled (Europe)	

Table 4. Installer Setup Menu. (Continued)

Installer Setup Number	Installer Setup Name	Default Setting	All Settings	Notes
0340	Remote Temperature Sensor	0	0—None 1—Outdoor for Display 2—Outdoor for Control 3—Remote 10K Indoor 4—Remote 20K Indoor	Averaging would not include on-board sensor. It is accomplished by series/parallel combinations. 2 applies only to Heat Pump applications (allowing compressor lockout while displaying temperature).
0350	Heat Pump Compressor Lockout	0	0—None 15(-9.5)—15°F (-9.5°C) 20(-6.5)—20°F (-6.5°C) 25(-4.0)—25°F (-4.0°C) 30(-1.0)—30°F (-1.0°C) 35(1.5)—35°F (1.5°C) 40(4.5)—40°F (4.5°C) 45(7.0)—45°F (7.0°C)	Only shown for heat pump systems with more heat stages than cool selected and remote sensor selection is outdoor for control. Must enforce a dead band between this and Auxiliary Lockout
0360	Heat Pump Auxiliary Lockout	0	0—None 40(4.5)—40°F (4.5°C) 45(7.0)—45°F (7.0°C) 50(10.0)—50°F (10.0°C) 55(13.0)—55°F (13.0°C) 60(15.5)—60°F (15.5°C)	Only shown for heat pump systems with more heat stages than cool selected and remote sensor selection is outdoor for control. Must enforce a dead band between this and Heat Pump Compressor Lockout.
0535	Temporary Occupied Duration Limit	3	0—no duration 1—one hour 2—two hours 3—three hours 4—four hours	0 means no limit
0540	Number of Periods	4	2—2 Periods 4—4 Periods	Does not appear if Non-programmable is chosen. Applies to all days of the week. With 2 selected the "Cancel Period" option does not appear on the display.
0580	Minimum Compressor Off Time	5	0—Off 2—2 minutes 3—3 minutes 4—4 minutes 5—5 minutes	Only shown if system has cool stages.
0600	Heat Temperature Range Stops	90	40 to 90°F (4 to 32°C)	Only shown if system has heat stages.
0610	Cool Temperature Range Stops	50	50 to 99°F (10 to 37°C)	Only shown if system has cool stages.
0640	Clock Format	12	12—12 Hour 24—24 Hour	
0650	Extended Fan-on time Heat	0	0—Off 90—90 seconds	Not displayed with fan set to fossil or with cool-only systems
0660	Extended Fan-on time Cool	0	0—Off 40—40 seconds	Only shown if system has cool stages.
0670	Keypad Lockout	0	0—Unlocked 1—Partial Lockout 1 2—Partial Lockout 2 3—Fully Locked	Unlocked: All functions accessible. Partial 1: Locks all but Holiday, Override, and Up/Down. Partial 2: Locks all but Holiday and Override. Full: Entire interface locked/non-functional.
0680	Temperature Control Heat	2	1—Less Aggressive 2—Standard 3—More Aggressive	Only shown if system has heat stages. Only integral gains affected. Affects control operation in all control regimes (not just recovery or setpoint change). More Aggressive stops signal prior to reaching the setpoint. (For use with oversized equipment.)
0685	Recovery Heat Ramp Rate	5	0-20°F/hour	Only shown if system has heat stages. 0 disables ramped recovery (step setpoint change at period start time).

Table 4. Installer Setup Menu. (Continued)

Installer Setup Number	Installer Setup Name	Default Setting	All Settings	Notes
0690	Temperature Control Cool	2	1—Less Aggressive 2—Standard 3—More Aggressive	Only shown if system has cool stages. Only integral gains affected. Affects control operation in all control regimes (not just recovery or setpoint change). More Aggressive stops signal prior to reaching the setpoint. (For use with oversized equipment.)
0695	Recovery Cool Ramp Rate	3	0-20°F/hour	Only shown if system has cool stages. 0 disables ramped recovery (step setpoint change at period start time).
0700	Temperature Display Offset	0	-3 (-1.5)—-3°F (-1.5°C) -2 (-1.0)—-2°F (-1.0°C) -1 (-0.5)—-1°F (-0.5°C) 0 (0.0)—0°F (0.0°C) 1 (0.5)—1°F (0.5°C) 2 (1.0)—2°F (1.0°C) 3 (1.5)—3°F (1.5°C)	This offset applies to both the control temperature and to the display temperature for indoor sensor (and remote indoor sensor).
0710	Restore Factory Defaults	0	0—No 1—Yes	Resets all ISU parameters to default values and resets the schedule to default Energy Star. Retains only calendar settings and time.
INSTALLER TESTS				
Test 1	Installer Test Cool	0	0—Off 1—Cool Stage 1 2—Cool Stage 2	
Test 2	Installer Test Fan	0	0—Off 1—Fan On	
Test 3	Installer Test Heat	0	0—Off 1—Heat Stage 1 2—Heat Stage 1 and 2 3—Heat Stage 1,2 and 3	
Test 4	Installer Test Auxiliary Heat	0	0—Auxiliary Heat Off 1—Auxiliary Heat On	
Test 8	Installer Test TOD/Economizer	0	0—TOD/Economizer Off 1—TOD/Economizer On	

NOTE: Press the Done button to exit the Installer System Test.

OPERATION

System Settings

Heat—Thermostat controls the heating system.

Off—Both heating and cooling systems are off.

Cool—Thermostat controls the cooling system.

Auto—Thermostat automatically changes between heat and cool operation, depending on indoor temperature.

Fan Settings

Auto —Fan runs only when heating/cooling system is on.

On—Fan runs continuously.

Table 5 shows default program settings. See Owner's Guide for complete instructions to change the program.

Table 5. Energy Star Default Program Settings.

Schedule Period	Time	Setpoints		Fan Setting
		Heat	Cool	
Occ1	8:00am	70°F (21°C)	78°F (25.5°C)	Auto
Unocc1	10:00pm	55°F (10°C)	85°F (29.5°C)	Auto
Occ2 ^a	—	—	—	—
Unocc2 ^a	—	—	—	—

^aThe thermostat default setting is two period only. To use four periods, change the appropriate setup parameter.

Minimum-Off Timer Compressor Protection

The thermostat has an adjustable Minimum-Off Timer that can be set from zero to five minutes (Factory Setting—five minutes). The Minimum-Off Timer can be bypassed through the Installer System Test or it can be bypassed permanently by setting the Minimum-Off Timer to 0 minutes in the Installer Setup. The Minimum-Off Timer is activated after the compressor turns off:

- If the thermostat is system powered (common wire), the Minimum-Off Timer is also activated upon initial startup and after power interruptions.
- If there is a call for cooling or heating during the Minimum-Off Time, the thermostat displays “Wait.”
- When the Minimum Off Timer expires, “Cool On” or “Heat On” (heat pumps only) appears solidly in the display and the compressor and fan turn on.

Outdoor or Indoor Temperature Sensor

Allow outdoor or indoor temperature sensor to absorb the air for a minimum of five minutes before taking a reading. See the Sensor instructions for more information.

Economizer/TOD Logic (Table 6)

Table 6. Operation of Terminal A.

Effective Occupancy	Call for Cool	Terminal A	
		Economizer	TOD
Occupied	—	Energized	Energized
Unoccupied	Yes	Energized	De-energized
	No	De-energized	De-energized
Override	—	Energized	Energized

Heat Pump Temperature Lockouts

Dual Fuel Heat Pump and Outdoor Sensor

In this operation, there is no external fossil fuel kit (dual fuel kit) installed; the thermostat controls this function:

1. Choose correct heat pump application in Installer Setup Number 0170.
2. Choose **Outdoor Temperature Sensor for Heat Pump Temperature Lockouts Option** in Installer Setup Number 0340.
3. Choose appropriate **Balance Point Temperature** in Installer Setup Number 0350.

OPERATION IN HEAT MODE ABOVE BALANCE POINT (OUTDOOR TEMPERATURE)

When the outdoor temperature is above the selected Balance Point Temperature (ISU 0350), only the compressor operates and the fan (G terminal) energizes when the thermostat calls for heat.

OPERATION IN HEAT MODE BELOW BALANCE POINT (OUTDOOR TEMPERATURE)

When the outdoor temperature is below the selected Balance Point Temperature (ISU 0350), only the Fossil Fuel (auxiliary heat) operates and the fan (G terminal) does not energize when the thermostat calls for heat.

Heat Pump with Auxiliary (Backup) Heat and Outdoor Temperature Sensor

1. Choose correct heat pump application in Installer Setup Number 0170.
2. Choose **Outdoor Temperature Sensor for Control Option** in Installer Setup Number 0340.
3. Choose **Compressor Lockout Temperature** in Installer Setup Number 0350.
4. Choose **Auxiliary Lockout Temperature** in Installer Setup Number 0360.

NOTE: There is a 5°F deadband between Compressor and Auxiliary Heat lockout temperatures.

Operation in Heat Mode

When the outdoor temperature is:

- Below the Compressor Lockout Temperature, only the Auxiliary Heat operates.
- Above the Auxiliary Lockout Temperature, only the Compressor operates. See Fig. 31.
- Between the two temperatures, both the Compressor and Auxiliary Heat operate.

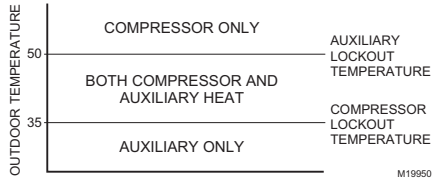

Fig. 27. Heat Pump Operation with Lockout Temperatures Set.

TROUBLESHOOTING (TABLE 7)

Table 7. Troubleshooting.

Symptom	Possible Cause	Action
Display does not come on.	Thermostat is not being powered.	Check for 24 Vac between C and Rc. Check that AAA batteries are installed correctly and are good.
Temperature settings do not change.	The upper or lower temperature limits were reached.	Check temperature setpoints. Check Installer Setup Numbers 0600 and 0610; modify as needed.
	The keypad is fully locked.	Check Installer Setup Number 0670 to change keypad locked options.
Heating or cooling does not come on.	Thermostat minimum off-time is activated.	Wait up to five minutes for the system to respond.
	System selection not set to Heat or Cool.	Set system Selection to correct position.
	System type Selection is incorrect.	Check Installer Setup Number 0170 and make sure correct System type is chosen.
Thermostat is calling for Heat (Heat on) or Cool (Cool on) but no heating or cooling is running.	Heating or cooling equipment is not operating.	Check wiring. Check Installer Setup Number 0170 and make sure correct system type is chosen. Verify operation of equipment in System Test mode.
Heat does not turn on (Heat On is solid in the display).	Heating equipment failure.	Check for 24 Vac at the equipment on the secondary side of the transformer between power and common. If voltage is not present, check the heating equipment to find the cause of the problem. Check for 24 Vac between the heat terminal (W) and transformer common. If 24 Vac is present, the thermostat is functional. Check the heating equipment to find the cause of the problem.
	Loose or broken wire connection between thermostat and heating equipment.	Check for 24 Vac between the heat terminal (W) and transformer common. If voltage is not present, check wire connection (loose or broken) between the thermostat and the heating equipment.
Heat pump puts out cool air in the heat mode and warm air in the cool mode.	Changeover Valve (Installer Setup Number 0190) is not configured to match the changeover required by the installed heat pump.	Set Changeover Valve (Installer Setup Number 0190) to match the changeover required by the installed heat pump.
Both the heating and cooling equipment are running at the same time.	The heating equipment is not a heat pump but the System Type (Installer Setup Number 0170) is set to Heat Pump.	Set System Type (Installer Setup Number 0170) to match the installed heating and/or cooling equipment.
	Heating and cooling wires are shorted together.	Separate the shorted heating and cooling wires.
Cooling does not turn on (Cool On is solid in the display).	Cooling equipment failure.	Check for 24 Vac at the equipment on the secondary side of the transformer between power and common. If voltage is not present, check the cooling equipment to find the cause of the problem. Check for 24 Vac between the cool terminal (Y) and transformer common. If 24 Vac is present, the thermostat is functional. Check the cooling equipment to find the cause of the problem.
	Loose or broken wire connection between thermostat and cooling equipment.	Check for 24 Vac between the cool terminal (Y) and transformer common. If voltage is not present, check the wire connection (loose or broken) between the thermostat and the cooling equipment.

Table 7. Troubleshooting. (Continued)

Symptom	Possible Cause	Action
Fan does not turn on in a call for heat (electric furnace).	Fan Control in Heating is set to Gas or Oil Furnace (Setting 0180).	Set Fan Control in Heating to Electric Furnace (Setting 0180).
Heating equipment is running in the cool mode.	Heating equipment is not a heat pump but System Type (Installer Setup Number 0170) is set to Heat Pump.	Set System Type (Installer Setup Number 0170) to match the installed heating and/or cooling equipment.
Heating equipment does not turn off and heat temperature setting is set below room temperature (Heat On is not in the display).	Heating equipment is not a heat pump but System Type (Installer Setup Number 0170) is set to Heat Pump.	Set System Type (Installer Setup Number 0170) to match the installed heating and/or cooling equipment.
Cannot set the system setting to Heat.	System Type (Installer Setup Number 0170) is set to Cool Only.	Set System Type (Installer Setup Number 0170) to match the installed heating and/or cooling equipment.
Cannot set the system setting to Cool.	System Type (Installer Setup Number 0170) is set to Heat Only or Heat Only with Fan.	Set System Type (Installer Setup Number 0170) to match the installed heating and/or cooling equipment.
Heat On is not in the display.	System setting is not set to Heat and/or temperature setting is not set above room temperature.	Set the system setting to Heat and set the temperature setting above the room temperature.
Cool On is not in the display.	System setting is not set to Cool and/or the temperature setting is not set below room temperature.	Set the system setting to Cool and set the temperature setting below the room temperature.
Wait is in the display.	Compressor minimum off timer is active.	Wait up to five minutes for the cooling or heating (heat pump) equipment to turn on.

SPECIFICATIONS

Electrical Ratings:

Terminal	Voltage (50/60 Hz)	Running Current
W (Heating)	20 - 30 Vac	0.02 - 1.0A
Y (Cooling)	20 - 30 Vac	0.02 - 1.0A
G (Fan)	20 - 30 Vac	0.02 - 0.60A
A (Economizer/TOD)	20 - 30 Vac	0.02 - 1.0A

Temperature Setting Range:

Heating: 40°F to 90°F (4.5°C to 32°C).
 Cooling: 50°F to 99°F (10°C to 37°C).

Operating Ambient Temperature:

0°F to 120°F (-18°C to 49°C).

Shipping Temperature:

-30°F to 150°F (-34.4°C to 65.6°C).

Operating Relative Humidity (Non-condensing):

5% to 90%.

Thermostat Dimensions: 3-3/4 in. (95 mm) high x 6 in. (152 mm) wide x 1-3/8in. (35 mm) deep.

Accessories:

- C7089U Outdoor Sensor: 10K ohm NTC.
- C7189U Remote Indoor Sensor: 10K ohm NTC.
- C7772 Flush-Mount Remote Indoor Sensor: 20K ohm NTC.
- T7770A1006 Wall-Mount Remote Indoor Sensor: 20K ohm NTC.
- T7770A3002 Wall-Mount Remote Indoor Sensor: 10K ohm NTC.

Perchlorate Material

This thermostat contains a Lithium battery which may contain Perchlorate material.

The following statement is required:
 Perchlorate Material—special handling may apply.
 See www.dtsc.ca.gov/hazardouswaste/perchlorate

Automation and Control Solutions

Honeywell International Inc.
 1985 Douglas Drive North
 Golden Valley, MN 55422
customer.honeywell.com

Honeywell Limited-Honeywell Limitée
 35 Dynamic Drive
 Toronto, Ontario M1V 4Z9

